

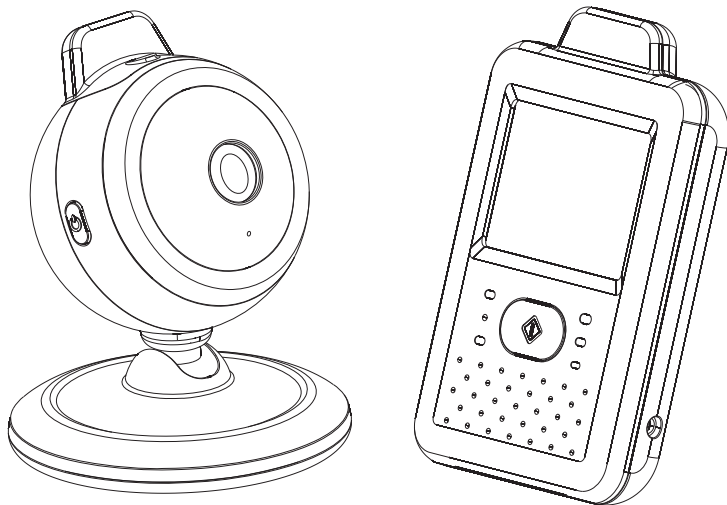


**SISTEMA DE TELEVIGILANCIA  
PARA BEBÉS**

**SISTEMA DE MONITORAMENTO  
REMOTO PARA BEBÊS**

**Modelo: MX-SVB7484**

User's Manual  
Manuel de l'utilisateur  
Manual del Usuario  
Bedienungsanleitung  
Manual do usuário



ENGLISH

FRANCAIS

ESPAÑOL

DEUTSCH

PORTUGUÊS

Figures and Quick Guide / Figures et Guide d'utilisation rapide  
/ Figuras y guía rápida / Abbildungen und Schnellanleitung  
/ Figuras e guia rápido

Product Layout / Description du produit / Vista general del producto  
/ Produktübersicht / Visão geral do produto

Camera / Caméra / Cámara / Kamera / Câmera

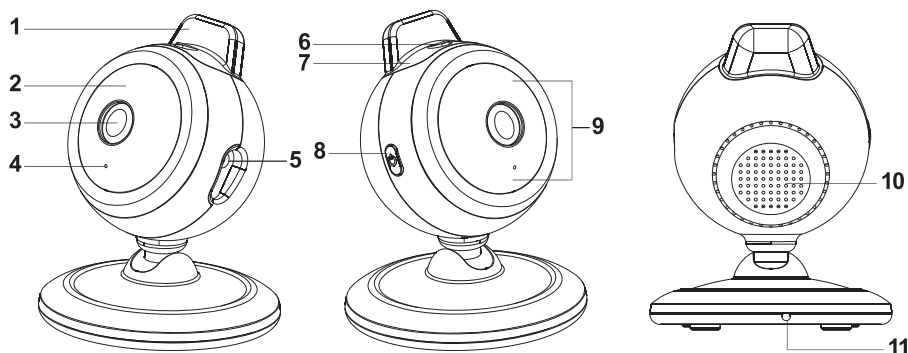


Fig. 1

Monitor / Moniteur

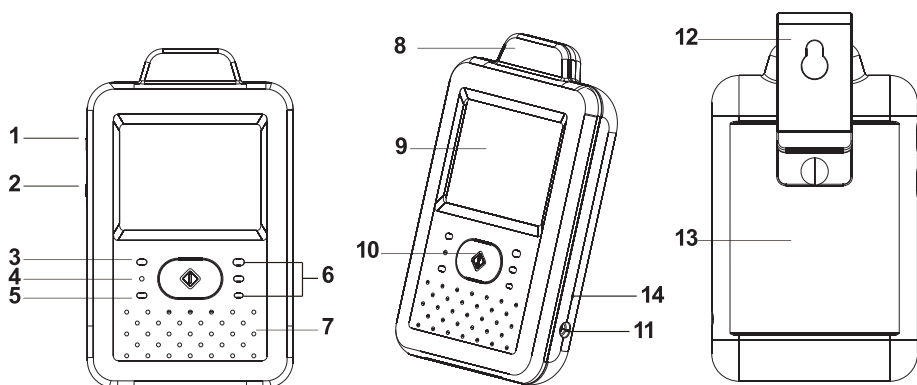


Fig. 2

**1 Camera Setup / Installation de la cámara / Configuración de la cámara / Kameraeinrichtung / Configurações da câmera**

**1.1 Power Supply - Alimentation - Avec alimentation secteur**  
Suministro de corriente - Stromversorgung – über Netzstrom  
Alimentazione - Alimentação

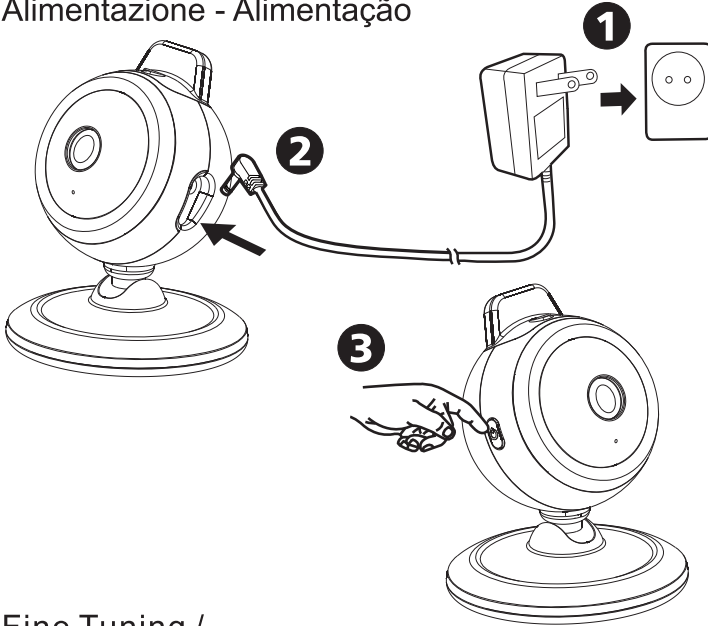


Fig. 3

**1.2 Fine Tuning / Réglages précis / Orientación / Feineinstellung / Orientação**

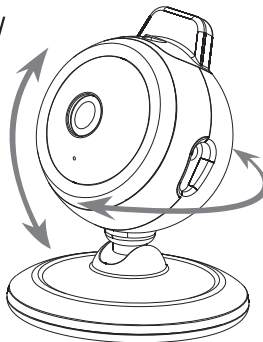


Fig. 4

**¡Muy importante!**

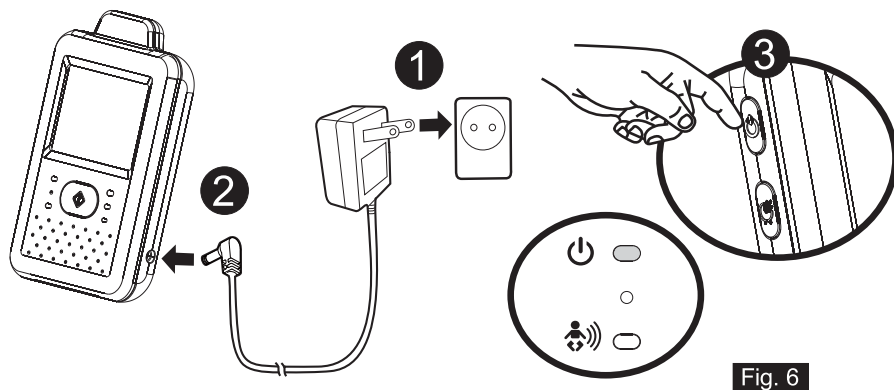
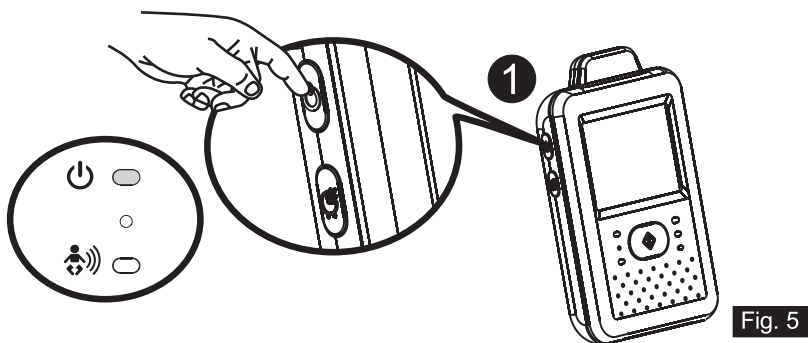
El adaptador de alimentación es el dispositivo de desconexión del equipo. La base de toma de corriente debe estar cerca del equipo y ser fácilmente accesible

**¡Muito importante!**

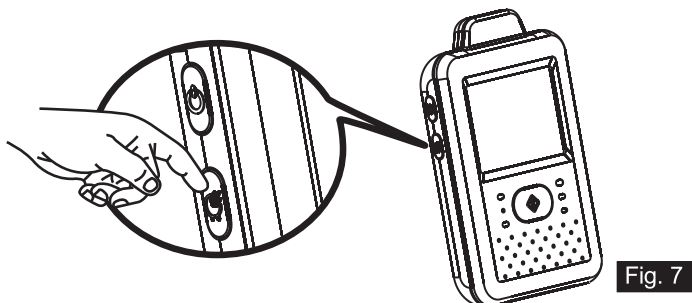
O adaptador de energia é o dispositivo de desconexão deste equipamento. A tomada deve estar perto do equipamento e ser facilmente acessível.

## 2 Monitor Setup / Installation du moniteur / Configuración del monitor / Monitoreinrichtung / Monitor as configurações

### 2.1 Power Supply / Alimentation / Suministro de corriente / Stromversorgung / Alimentação



### 2.2 Talkback Function / Fonction de réponse / Función de intercomunicador / Gegensprechfunktion / Intercomunicador



### 3 Menu Options / Options du menu / Opciones del menú / Menüoptionen / Opções de menu

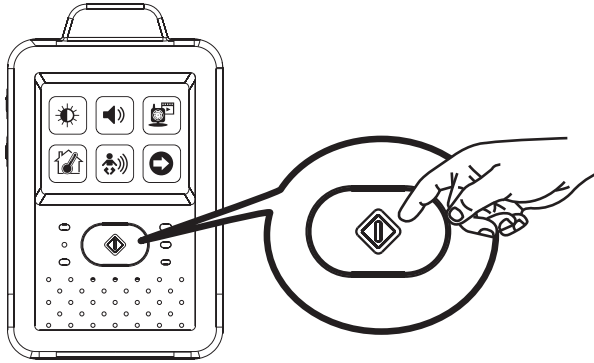


Fig. 8

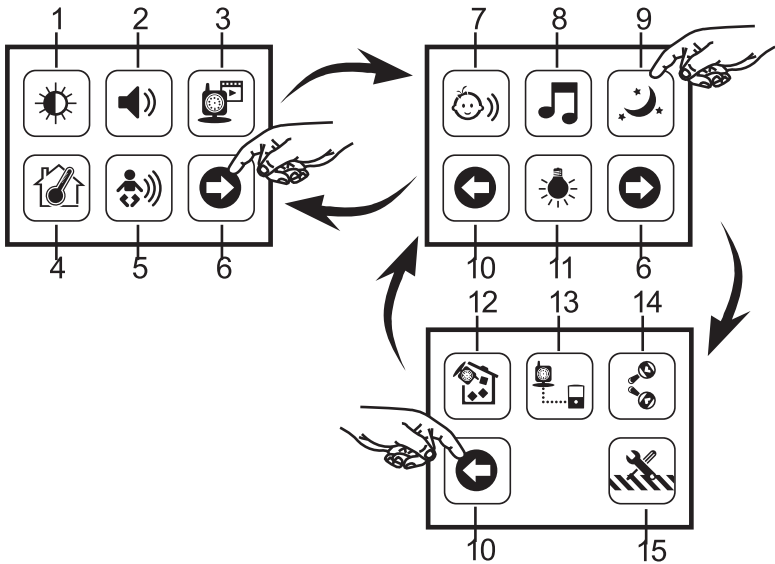


Fig. 9

### 3.1 Brightness Setting / Réglage de la luminosité / Configuración del brillo / Helligkeitseinstellung / Ajustar o brilho

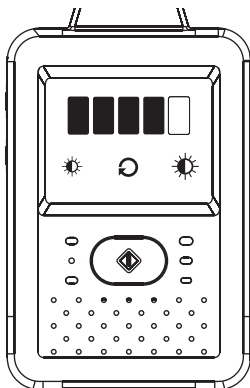


Fig. 10

### 3.2 Volume Setting / Réglage du volume / Ajustar el volumen / Lautstärkeeinstellung / Ajustar o volume

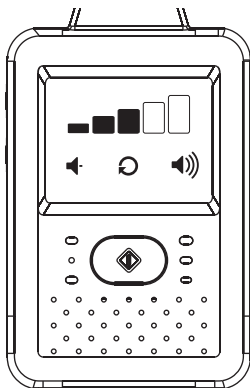


Fig. 11

### 3.3 Camera Selection / Sélection de la caméra / Selección de la cámara / Kameraauswahl / Seleccionando a câmera

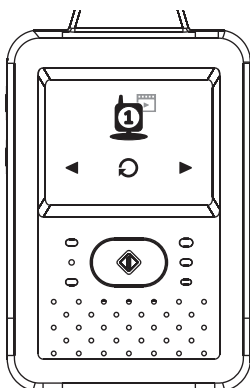
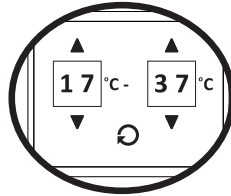


Fig. 12

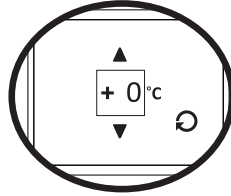
**3.4 Temperature Setting / Réglage de la température / Configuración de la temperatura / Temperatureinstellung / Configuração da temperatura**



**Fig. 13**

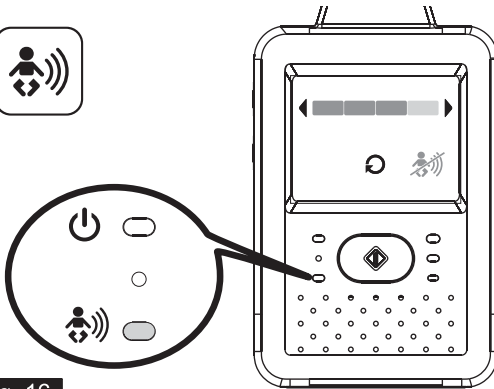


**Fig. 14**



**Fig. 15**

**3.5 VOX (Voice-Operated Transmission) Function / Fonction TCV (Transmission de Commande Vocale) / Función VOX (transmisión activada por voz) / VOX-Funktion (geräuschaktivierte Übertragung) / Função VOX (transmissão de voz ativado)**



**Fig. 16**

### 3.6 Volume Setting(Camera) / Réglage du volume(Caméra) / Configuración del volumen de la cámara (intercomunicador) / Lautstärkeeinstellung(Kamera) / configurações de volume da câmara (intercomunicador)

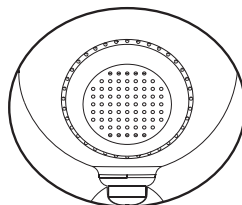
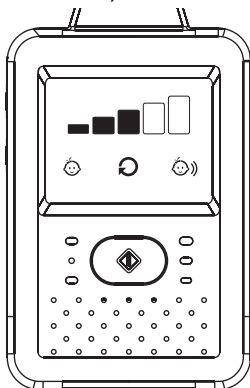


Fig. 17

### 3.7 Music Function / Fonction de musique / Melodías de cuna / Musikfunktion / Músicas berço

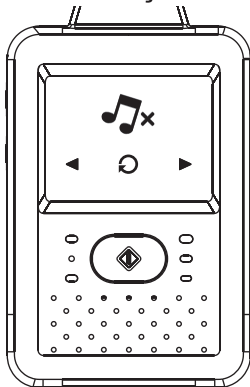


Fig. 18

### 3.8 Night Light / Veilleuse / Luz de compañía / Nachtlcht / Luz da noite

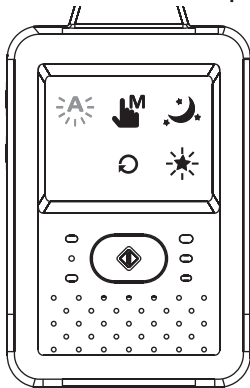


Fig. 19



### 3.9 Display Frequency and White Balance Setting / Paramètres d'affichage et de balance des blancs / Parámetros frecuencia de visualización y Balance de blanco / Einstellung der Anzeigefrequenz und des Weißabgleichs / Exibição de parâmetros de frequência e Equilíbrio de Branco

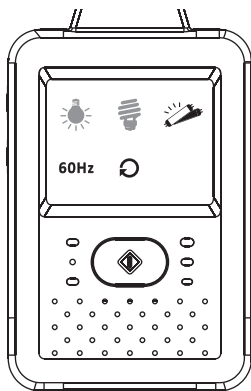


Fig. 20

### 3.10 Delete Camera / supprimer une caméra / Eliminar cámara / Kamera hinzufügen / Retire a câmera

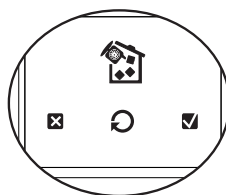
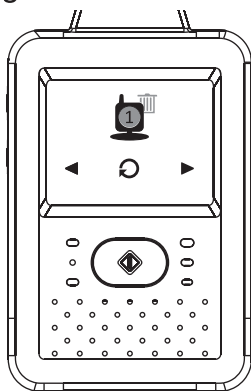
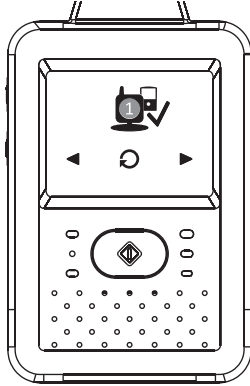
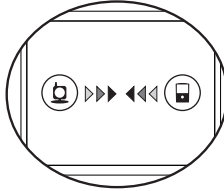


Fig. 21

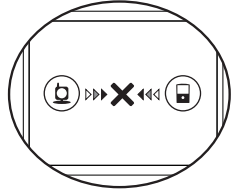
**3.11 ADD Camera / Ajouter caméra / Añadir cámara / Kamera löschen / Adicionar câmara**



**Fig. 22**

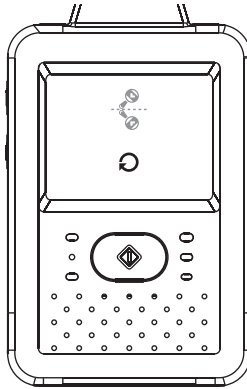


**Fig. 23**



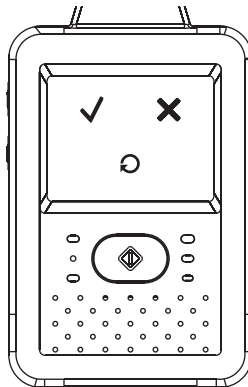
**Fig. 24**

**3.12 Flip Function / Fonction Retourner / Voltar la imagen / Umdrehfunktion / Inverter a imagen**



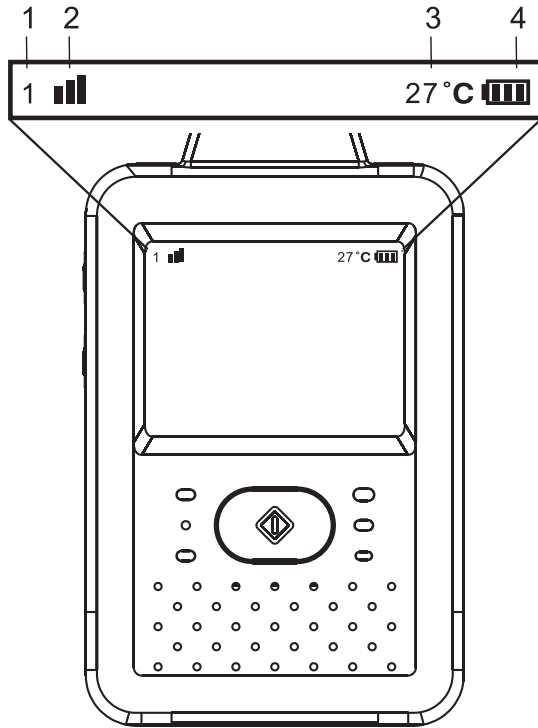
**Fig. 25**

**3.13 Restore Default / Restaurer défaut / Restaurar los valores predeterminados / Werkseinstellungen wiederherstellen / Restore defaults**



**Fig. 26**

**4** Status Information / Informations de statut / Información del estado / Statusinformationen / As informações de status



**Fig. 27**



# Package Contents

- One Camera
- One Monitor
- Two Power Adapters
- Two Cable Clips
- Two Screws and Two Wall Anchors
- This User's Manual

## Product Layout

### Camera (Fig. 1)

1. Antenna
2. Power Indicator LED
3. Lens
4. Microphone
5. Power Adapter Plug
6. Light Sensor
7. Night Light
8. Power/Pairing Button
9. Infrared LEDs
10. Speaker
11. Temperature Sensor

### Monitor (Fig. 2)

1. Power Button
2. Talkback Button
3. Power Indicator LED
4. Microphone
5. VOX Indicator LED
6. Volume Indicator LEDs
7. Speaker
8. Antenna
9. LCD Screen (Touch Panel)
10. Menu Button
11. Power Adapter Plug
12. Holder
13. Built-in Battery (3.7V 1000mAh Li-ion)
14. Shutdown Key

# Setup

## 1 Camera Setup

### 1.1 Power Supply - Using AC Power

Plug one end of the provided power adapter into a wall outlet and the other end into the back of the camera. See Fig. 3.

**Note 1:** Use the adapter labeled OUTPUT: 6V DC with the camera.

**Note 2:** Press and hold the Power button over two seconds to turn off the camera.

### 1.2 Fine Tuning

Place the camera in a convenient location, point the lens toward the observation area. See Fig. 4.

### 1.3 Night Vision



The camera has eight high-intensity LEDs for picking up clear images in the dark. When the light sensor detects low ambient light levels, the LEDs will be automatically activated.

### 1.4 Room Temperature Measurement

Temperature sensor can measure room temperature on camera side and the room temperature indicator will be displayed on the screen of the monitor unit.

### 1.5 Pairing

The system comes with a camera unit that has already been paired with the monitor unit. The pairing function gives each camera unit a separate channel on the monitor unit. This is necessary for configuring additional camera units.


1. Press and hold power button over 3 seconds on camera. The power LED (red light) and night light (orange light) will start blinking. This will turn on the power of camera and camera will wait for pairing.  
See Fig. 23.
2. Press the Power button  to turn on the monitor and the power LED will light up (green).
3. In the submenu (13. Add Camera see Fig. 9.) on monitor.
4. Please choose which number of cameras you want to add, and then press the icon.  See Fig. 22.
5. Pairing is completed, it will show " ✓ " on the monitor.
6. Pairing is failed, it will show the picture on the monitor. See Fig. 24.

**Note :** Make sure the camera and the monitor are within range of each other.

If there is out of range, the picture will be displayed on the LCD screen and the warning sound will be emitted from the monitor unit if the monitor exceeds the range (unlink). The warning sound will be emitted from the monitor until you press any button to stop.

## 2 Monitor Setup

### 2.1 Power Supply

1. The monitor uses built-in 3.7V 1000mAh (Li-ion) battery.
2. Press the POWER button  to turn on the monitor. See Fig. 5.

**Note 1:** When power is sufficient, the "Power" LED will light up (green light).

**Note 2:** Press and hold the Power button over two seconds to turn off the monitor.

#### Charging

1. Plug one end of the provided power adapter into a wall outlet and the other end into the monitor.



**Note :** Use the adapter labeled OUTPUT: 6V DC with the monitor.

2. Press the POWER button  to turn on the monitor. See Fig. 6.


**Note 1:** When power on the monitor, "Power" LED will appear orange

**Note 2:** Press and hold the Power button over two seconds to turn off the monitor.

**Note 3:** When power on and charging starts, and battery status will appear

. If charging is finished (fully charged) the battery status will appear . When power off and charging starts, and "Power" LED will appear red. If charging is finished (fully charged) the "Power" LED will turn green.

### 2.2 Talkback Function


Press the talkback button  to speak through the camera unit. See Fig. 7.

### 2.3 Shutdown Key

In case of system crash, press the shutdown key by small object or pin and the monitor unit will shut down immediately.

## 3

### Menu Options

1. Press the menu button  on the monitor unit to display the main menu on the screen (touch panel). See Fig. 8.
2. There are three main menus. See Fig. 9.
  - (1) Brightness Setting
  - (2) Volume Setting (Monitor)
  - (3) Camera Selection
  - (4) Temperature Setting
  - (5) VOX Function
  - (6) Next Page
  - (7) Volume Setting (Camera)
  - (8) Music Function
  - (9) Night Light Setting
  - (10) Last Page
  - (11) Display Frequency and White Balance Setting
  - (12) Delete Camera
  - (13) Add Camera
  - (14) Flip Function
  - (15) Restore Default

#### 3.1 Brightness Setting ( Brightness )

In this submenu you can adjust brightness of the screen. See Fig. 10.

#### 3.2 Volume Setting ( Monitor )

In this submenu you can adjust volume level on monitor side. See Fig. 11.



#### 3.3 Camera Selection ( Camera Select )

In this submenu you can select which camera that you want to display on the screen. See Fig. 12.

#### 3.4 Temperature Setting ( Temp. Setting )

1. In this submenu you can choose the temperature unit between degrees Celsius or degrees Fahrenheit. See Fig. 13.



2. You can set the temperature range of the temperature alert.  When the temperature is outside the range, the temperature indicator on the panel of monitor will blinking. If you enable the temperature alert and the alert icon will light up, the warning sound will be emitted from the monitor unit if the temperature is outside the range until you disable the temperature alert.   
See Fig. 14.


**Note :** The lowest range (left side) is between 0°C to 25°C (32°F to 77°F ) and the highest range (right side) is between 26°C to 38°C (78°F to 99°F ).

3. You can set temperature compensation manually for adjustment in performance of system to compensate for exact temperature of camera side.



**Note:** The range of temperature compensation that can be set is  $\pm 2^{\circ}\text{C}$  ( $\pm 2^{\circ}\text{F}$ )  
See Fig. 15.

### 3.5 VOX (Voice-Operated Transmission) Function





1. This submenu lets you choose the VOX sensitivity level. With the level set to high, the microphone will detect lower sounds. See Fig. 16.
2. When you enable the VOX on the monitor unit, the icon  will light up. Press the menu button to back to display screen for complete setting and the VOX LED will remain ON (blue light).
3. This will turn off the screen within 10 seconds and enter power saving mode.
4. When the sound from the camera reaches the set level, the screen will turn on automatically and a warning sound will be emitted from the monitor unit.

### 3.6 Volume Setting (Camera)





In this submenu you can adjust volume level on camera side. See Fig. 17.

### 3.7 Music Function

You can play the music with the camera (three pieces of music) .

1. Press the music button  , the camera will play music. See Fig. 18.
2. Press the button  , the camera will play the next song.
3. You can play all lullabies when you choose this  icon.
4. You will stop the lullaby when you choose this  icon.

### 3.8 Night Light Setting

1. When you enable the auto mode  , the icon will light up. You can choose the sensitivity level. With the level set to high, the light will detect higher light. See Fig. 19.
2. When the light from the camera reaches the set level, the night light will turn on as setting.
3. When you enable the manual mode  , you can turn ON/OFF the night light as setting.
4. Press the icon  , you can change the color of night light. There are three colors of night light (yellow, green, orange).
5. Press the icon  , you can change the level of brightness. There are four levels of brightness.

### 3.9 Display Frequency and White Balance Setting

1. In this submenu you can choose what frequency and color temperature are better on the monitor. See Fig. 20.
2. There are three types of color temperature and two frequencies (50Hz or 60Hz).



### 3.10 Delete Camera

In this submenu you can delete a paired camera.

1. Please press which number of cameras you want to delete. See Fig. 21.
2. Press  to delete.

### 3.11 Add Camera



The system comes with a camera unit that has already been paired with the monitor unit. The pairing function gives each camera unit a separate channel on the monitor unit. This is necessary for configuring additional camera units.

1. In this submenu you can add a new camera. See Fig. 22.
2. Please choose which number of cameras you want to add, and then press the icon .
3. The monitor will wait for pairing and then please also press the pairing button over three seconds on camera side. You don't need to turn on the power of camera.
4. Pairing is completed, it will show "  " on the monitor.
5. Pairing is failed, it will show the picture on the monitor. See Fig. 24.

## 3.12 Flip Function

In this submenu you can flip the video horizontally when mounting the camera on the ceiling. See Fig. 25.

## 3.13 Restore Default

In this submenu you can reset the system to default.  Press  to make sure. See Fig. 26.

# 4 Status Information


## 4.1 Status Bar

The status bar will be displayed on the top of the screen. See Fig. 27.

1. Camera number indicator
2. Signal strength indicator
3. Temperature indicator (Camera side)
4. Battery status / Charging indicator

## 4.2 Warning Alarm

The warning sound will be emitted from the monitor unit in the following cases.

Status	Indication	Action
Out of range Lost connection	Continuous beeps for one minute	Move the monitor closer to the camera. Check the power of camera.
Temperature alarm	2 consecutive beeps and temperature indicator on the screen blinking	Check the temperature of camera side. Disable temperature alert (See Setup 3.4)
VOX alarm	3 consecutive beeps	Disable VOX function (See Setup 3.5)
Low battery	2 consecutive beeps and  on the screen blinking	Connect the monitor unit to the AC adapter. (See Setup 2.1)

**Note :** You can press any key of monitor stop the alarm.

# Troubleshooting

## You don't getting any signal at all

- Make sure the camera and the monitor are turned on.
- Make sure the power plugs are pushed all the way in.

## If the signal is poor, or there is interference

- If there is a microwave oven in use in the path between the camera and monitor, remove the microwave oven or turn it off.
- Make sure the camera and the monitor are within range of each other (range of approximately 984 feet; 300 meters in a clear line of sight).

## Care and Maintenance

- Keep all parts and accessories out of children's reach.
- Fingerprints or dirt on the lens surface can adversely affect camera performances. Avoid touching the lens surface with your fingers.
- Should the lens become dirty, use a blower to blow off dirt and dust, or a soft, dry cloth to wipe off the lens.
- Keep the camera dry. Precipitation, humidity, and other liquids contain minerals will corrode electronic circuits.
- Do not use or store in dusty, dirty areas.
- Do not store in hot areas. High temperatures can shorten the life of electronic devices and warp or melt certain plastics.
- Do not store in very cold areas. When the system warms up (to its normal temperature), moisture can form inside the case, which may damage electronic circuit boards.
- Do not attempt to open the case. Non-expert handling of the device may damage the system.
- Avoid dropping or strong shocks.
- Operate this product using only with the power supply included or provided as an accessory.
- Do not overload electrical outlets or extension cords this can result in fire or electric shocks.
- Do remember that you are using public airwaves when you use the system and that sound and video may be broadcast to other 2.4 GHz receiving devices. Conversations, even from rooms near the camera, may be broadcast. To protect the privacy of your home, always turn the camera off when not in use.

## FCC Statement

This equipment has been tested and found to comply with the limits for a Class B digital device, pursuant to Part 15 of the FCC Rules. These limits are designed to provide reasonable protection against harmful interference in a residential installation. This equipment generates, uses and can radiate radio frequency energy and, if not installed and used in accordance with the instructions, may cause harmful interference to radio communications. However, there is no guarantee that interference will not occur in a particular installation. If this equipment does cause harmful interference to radio or television reception, which can be determined by turning the equipment off and on, the user is encouraged to try to correct the interference by one or more of the following measures:

- Reorient or relocate the receiving antenna
- Increase the separation between the equipment and receiver
- Connect the equipment into an outlet on a circuit different from that to which the receiver is connected
- Consult the dealer or an experienced radio/TV technician for help

This device complies with Part 15 of the FCC Rules. Operation is subject to the following two conditions: (1) this device may not cause harmful interference, and (2) this device must accept any interference received, including interference that may cause undesired operation.

## Caution

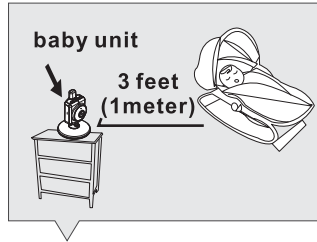
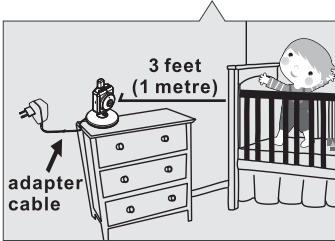
- To comply with FCC RF exposure compliance requirements, a separation distance of at least 20 cm must be maintained between the antenna of this device and all persons.
- This Transmitter must not be co-located or operating in conjunction with any other antenna or transmitter.
- Changes or modifications to this unit not expressly approved by the party responsible for compliance could void the user authority to operate the equipment.

# Following the safety tips

## To prevent deaths and injuries associated with baby monitor cords :

- Make sure the baby unit and AC adapter cords are always out of reach of the baby at least 3 feet (1 meter) away.

**Note :** It's important even if your baby is not yet standing or mobile.



- Use a wireless baby monitor to avoid risk of strangulation.
- Never use extension cords with AC adapters. Only use the AC adapters provided.

## Specifications

Camera		Monitor	
Frequency	2.4 GHz	Frequency	2.4 GHz
Antenna	Monopole antenna	Antenna	Monopole antenna
Transmission distance	300m (LoS)	LCD screen size	Touch panel 2.4-inch
Modulation	GFSK	Number of color	Full-color
Date rate	4M	Dimensions	68(W) x 112.1(H) x 20.3(D) mm
Image sensor	Color CMOS	Weight	104g (with battery)
Effective pixels	320H x 240V pixels	Power	DC 6V, 800mA;
Lens	f 3.0mm, F2.4		built-in 3.7V 1000mA Li-ion battery
Viewing angle	Horizontally 290°, Vertically 72°	Operating temperature	0°C ~ 40°C (32°F ~ 104°F)
Dimensions	80(W) x 101(H) x 80(D) mm		
Power	DC 6V, 800mA		
Operating temperature	0°C ~ 40°C (32°F ~ 104°F)		

*Specifications subject to change without notice*



This device is for indoor use only

This item is in compliance with the essential requirements and other relevant provisions of Directive 1999/5/EC.